



1. 使用環境條件

Apply Environmental Condition :

No.	項目 item	規格 standard
1-1	保存溫度 Storage Temperature Range	-20°C ~ 60°C
1-2	操作溫度 Operating Temperature Range	-10°C ~ 60°C
1-3	操作電壓 Operating Voltage Range	8.4V~12V

2. 測試環境

Standard Test Environment :

2-1	測試環境 Standard Test Environment	每一个检查必须是正常的温度和湿度进行测量，温度 25 ± 5°C，相对湿度 65 ± 10%，在按照本规范的标准测试条件下判断特征。 Every characteristic of the inspect must be normal temperature and humidity carry out the test , temperature 25±5°C and relative humidity 65±10% of judgment made in accordance with this specification standard testing conditions.
-----	-----------------------------------	--

3. 外觀檢查

Appearance Inspection :

No.	項目 item	規格 standard
3-1	外觀尺寸 Outline Drawing	尺寸见附件 Dimension see the attachment
3-2	外觀 Appearance	无损坏，不允许影响功能 No damage which affects functions allowed



4. 電氣特性

Electrical Specification (Function of the Performance) :

No.	項目 item	8.4V	12V
4-1	空載轉速 Operating speed (at no load)	0.18 sec/60°	0.10 sec/60°
4-2	空載電流 Running current (at no load)	200 mA	200 mA
4-3	停止扭力 Stall torque (at locked)	50 kg-cm	75 kg-cm
4-4	停止電流 Stall current (at locked)	2300 mA	3300 mA
4-5	待機電流 Idle current (at stopped)	60 mA	60 mA

注：項目 4-2 定義平均值時，伺服器無負荷運行

Note: Item 4-2 definition is average value when the servo running with no load

5. 機械特性

Mechanical Specification :

No.	項目 item	規格 standard
5-1	齒輪材料 Materials of the gear	鋼齒 Steel
5-2	機構極限角度 Limit angle	180° ± 10°
5-3	重量 Weight	83 ± 1g
5-4	導線規格 Connector wire gauge	#26 PVC
5-5	導線長度 Connector wire length	360 ± 5 mm
5-6	舵片規格 Horn gear spline	25T/φ5.80
5-7	舵片種類 Horn type	半臂，一字 Single, Double
5-8	減速比 Reduction ratio	1/306



Product Name
無刷伺服器 Brushless Servo

Model No.
T70-12V

Version
V1

Page
2/3

6. 控制特性

Control Specification :

No.	項目 item	规格 standard
6-1	控制系統 Control system	改变脉冲宽度 Pulse Width Modification
6-2	放大器種類 Amplifier type	数字控制器 Digital Controller
6-3	操作角度 Operating travel	90° (在 1000→2000 μ sec)
6-4	中立位置 Neutral position	1500 μ sec
6-5	脈波訊號虛位 Dead band width	2 μ sec
6-6	旋轉方向 Rotating direction	顺时针 (在 900→2100 μ sec) Cockwise (when 900→2100 μ sec)
6-7	脈波寬度範圍 Pulse width range	900→2100 μ sec
6-8	可作動角度範圍 Maximum travel	大约 110° (在 900→2100 μ sec) Approx 110° (when 900→2100 μ sec)

单位: mm

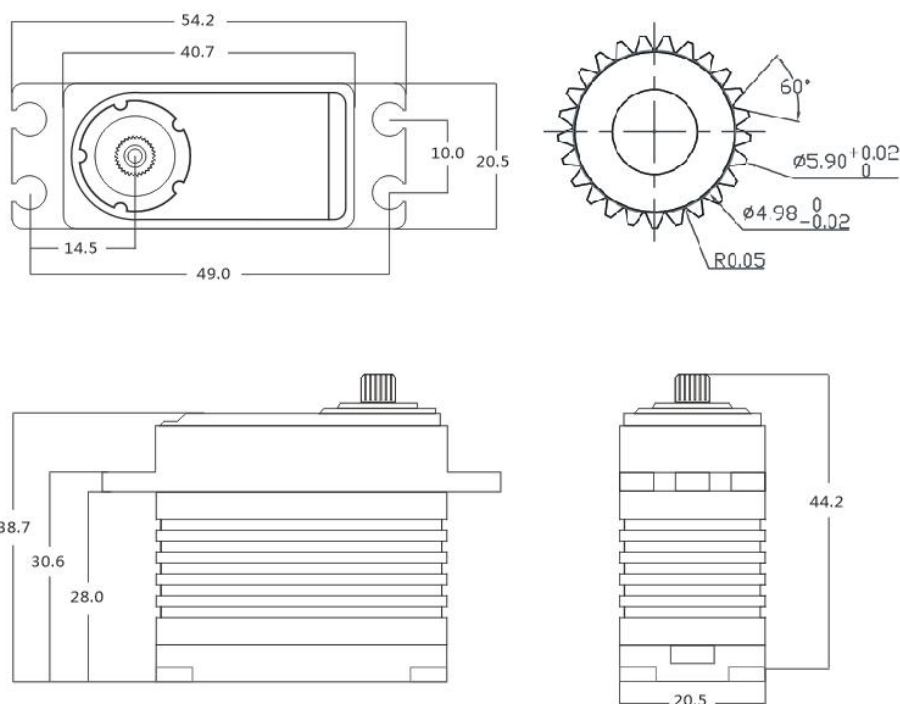

Product Name
無刷伺服器 **Brushless Servo**

Model No.
T70-12V

Version
V1

Page
3/3